

LAVATORY FAUCET K-7305

ADA

Features

- Brass construction
- Brass valve bodies
- Quarter-turn washerless ceramic disc valves
- 5-1/4" (13.3 cm) spout
- 2.0 gallons (7.6 L) per minute flow rate [max at 60 psi (4.14 bar)]
- Available with standard or vandal-resistant Water-Guard® aerator
- Variety of handle style options

Codes/Standards Applicable

Specified model meets or exceeds the following:

- ASME A112.18.1/CSA B125.1
- Energy Policy Act of 1992
- IAPMO/UPC
- ADA

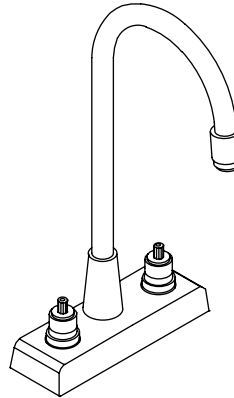

K-7305-K

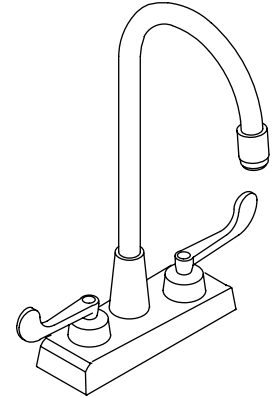

K-7305-5A





Colors/Finishes

- CP: Polished Chrome

Specified Model

Base Faucet: For complete faucet, both base faucet and handle choice must be specified.

Model	Description	Colors/Finishes
K-7305-K	Triton™ faucet with standard aerator but without handles or drain	<input type="checkbox"/> CP
K-7305-KE	Triton™ faucet with vandal-resistant Water-Guard® aerator but without handles or drain	<input type="checkbox"/> CP
K-7305-5A	Triton™ faucet with standard aerator and wristblade lever handles but without drain	<input type="checkbox"/> CP

Required Accessories (Includes Two Handles)			 ADA	 ADA	 ADA
K-16010-2	Triton™ standard handles	<input type="checkbox"/> CP			
K-16010-3	Triton™ cross handles		<input type="checkbox"/> CP		
K-16010-4	Triton™ lever handles			<input type="checkbox"/> CP	
K-16010-5	Triton™ wristblade lever handles				<input type="checkbox"/> CP

Product Specification

Two-handle centerset lavatory faucet shall be of brass construction. Faucet shall feature brass valve bodies. Faucet shall feature quarter-turn washerless ceramic disc valves, assuring positive handle stop positioning. Product shall be less drain and lift rod. Product shall include 4" (10.2 cm) centers, 5-1/4" (13.3 cm) gooseneck spout, and standard or vandal-resistant Water-Guard® aerator. Base faucet shall be Kohler Model K-7305-_____-CP and handles shall be Kohler Model K-16010-_____-CP **OR** complete faucet shall be Kohler Model K-7305-5A-CP.

TRITON®

Technical Information

Applicable faucet:	
With standard aerator but without handles or drain*	K-7305-K
With vandal-resistant Water-Guard® aerator but without handles or drain*	K-7305-KE
With standard aerator and wristblade lever handles but without drain	K-7305-5A
Applicable Triton™ handles:	
Standard handles	K-16010-2
Cross handles	K-16010-3
Lever handles	K-16010-4
Wristblade lever handles	K-16010-5
* Handles must be ordered to complete faucet.	
Cross and lever handles are ADA compliant.	ADA

Installation Notes

Install this product according to the installation guide.

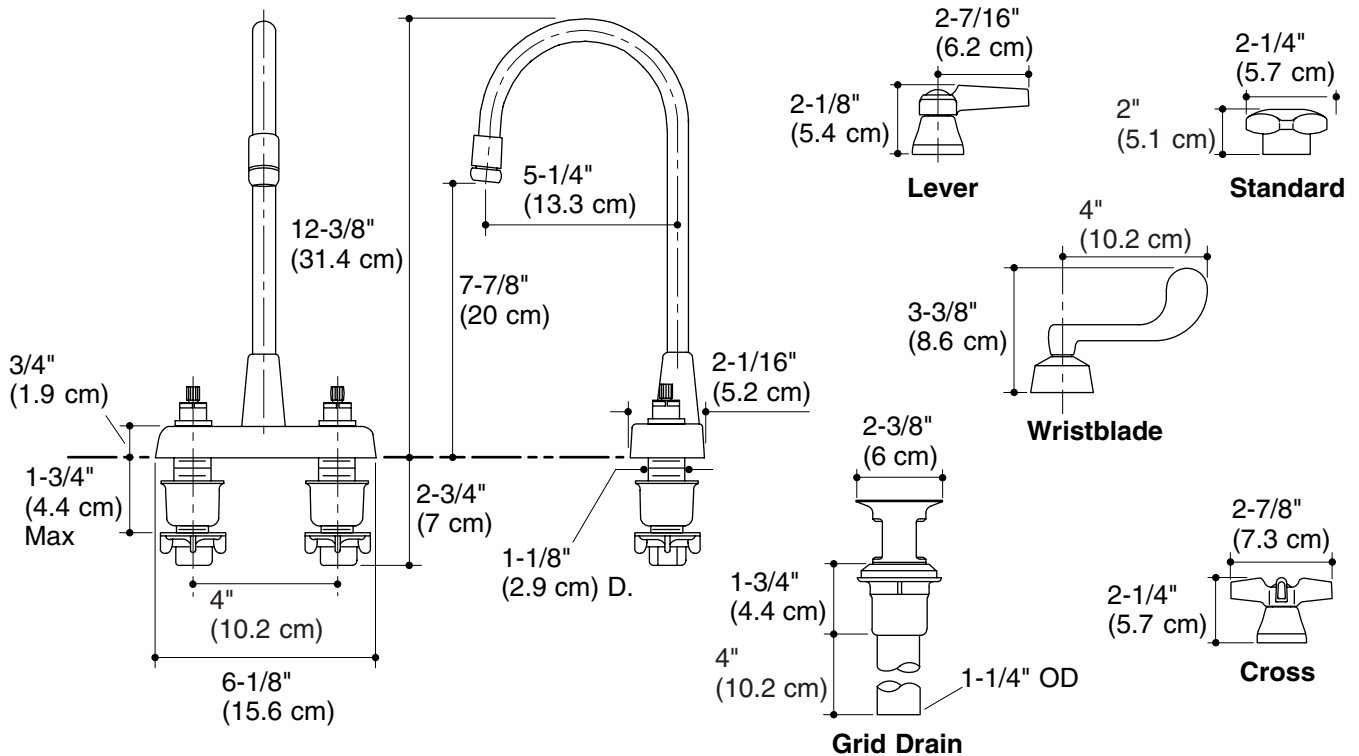

Product Diagram