

EBF-85

► **Description**

Battery Powered, Sensor Operated Electronic Hand Washing Faucet for tempered or hot/cold water operation.

► **Flow Rate**

0.5 gpm/1.9 Lpm Vandal Resistant Spray Head
(See **Accessories** for other Spray Head options)

► **Specifications**

ADA Compliant, Sensor Activated, Battery Powered, Chrome Plated Brass Hand Washing Faucet with the following features:

- Splash-proof Circuit Control Module
- Fiber Optic, Automatic, Self-adaptive Sensing
- Audible Tone Low Battery Indicator
- Serviceable Filtered Solenoid Valve
- Bak-Chek Tee for Hot/Cold Supply
- Trim Plate with Anti-Rotation Pin (specify 4" or 8")
- Vandal Resistant Spray Head with Pressure Compensating Flow Control
- Polypropylene Optic Cable Protection
- Includes four (4) C-cell Alkaline Batteries

► **Variations**

(Add suffix to Model Number for inclusion with Faucet)

• **Trim Plate** (must be specified)

- 4** Trim Plate for 4" Center-set Sink
- 8** Trim Plate for 8" Center-set Sink

• **Plug-in Adapter**

- R** Plug-in Adapter
(includes 6 volt transformer for hard wire installation)

• **Temperature Mixing Valves** (optional)

- ADM** Above Deck Mechanical Mixing Valve
 - BDM** Below Deck Mechanical Mixing Valve
 - BDT** Below Deck Thermostatic Mixing Valve
- Bak-Chek Tee not required or provided when a Temperature Mixing Valve is included with the faucet.

Consult Factory for Finish Variations

► **Accessories** (Specify separately)

• **Vandal Resistant Spray Heads**

- ETF-1027-A** 2.2 gpm/8.3 Lpm Laminar Flow Spray Head
(recommended for medical applications)
- ETF-1022-A** 2.2 gpm/8.3 Lpm Aerator

• **Grid Strainer**

- ETF-460-A** Chrome Plated Brass Grid Strainer w/1/4" Outlet Tube

See OPTIMA Accessories Section of the Sloan Catalog for a complete listing of OPTIMA Faucet Accessories and Variations.



► **ADA Compliant**

► **Automatic**

The Sloan OPTIMA Plus[®] EBF-85 Battery Operated, Electronic Hand Washing Faucet operates by means of an adaptive infrared sensor that is linked to the faucet by a fiber optic cable. Once the user's hands enter the sensor's effective range, the Solenoid activates the water flow. Tempered water flows from the Faucet until hands are moved away. The Faucet then automatically shuts off.

► **Hygienic**

The ultimate in sanitary protection — there are no handles to turn or buttons to push. Helps to control the spread of infectious diseases.

► **Economical**

Automatic operation provides water usage savings over other faucet devices. Reduces maintenance and operation costs. Self-adaptive Range Adjustment makes installation quick and easy. Battery operation ideal for Retrofit installations.

► **Warranty**

3 year (limited)

► **Made in the U.S.A.**

► **ASME A112.18.1M**

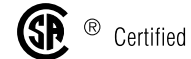

This space for Architect/Engineer approval

Job Name _____ Date _____

Model Specified _____ Quantity _____

Variations Specified _____

Customer/Wholesaler _____

Contractor _____

Architect _____

EBF-85

Description

Battery Powered, Sensor Operated Electronic Hand Washing Faucet for tempered or hot/cold water operation.

Flow Rate

□ 0.5 gpm/1.9 Lpm Vandal Resistant Spray Head
(See **Accessories** for other Spray Head options)

ELECTRICAL SPECIFICATIONS

Control Circuit

6 VDC — Operates on four (4) alkaline C-cell batteries. Self-adaptive Range Adjustment, Audible Troubleshooting and Low Battery Indicator. Fiber Optic Cable between Electronic Module and Faucet keeps all electronic signals below the sink.

Battery Life

2 years at 8,000 cycles/month

OPTIMA® Sensor Range

Nominal: 4" - 5" (102 mm - 127 mm)
Self-adaptive Zone: 2" - 8" (51 mm - 203 mm) — Faucet self-adjustment range within this zone dependent upon depth and reflectivity of basin.

Solenoid Valve

Low Energy Latching Solenoid with Self-cleaning By-pass and Integral Clean Out Strainer Filter.

FAUCET DIMENSIONS

(Shown with 4" Trim Plate)

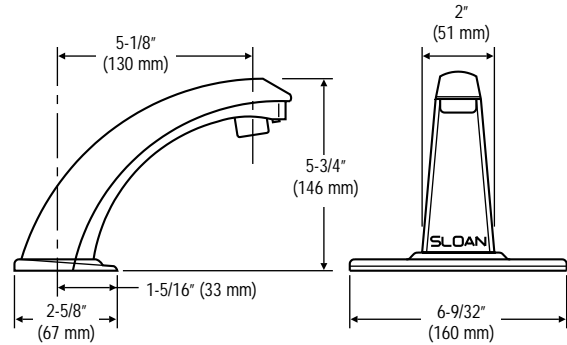

Time Out Adjustment Settings

30 seconds — The Faucet Time out Setting determines the maximum time the faucet will run upon continuous detection. The EBF-85 is factory set at the 30 second time out. Consult factory for time out settings to meet individual application requirements.

Maximum Distance Control Module may be Installed from Spout

30" (762 mm)

OPERATION

1. Continuous, invisible light beams are emitted from the OPTIMA® Sensor. Fiber optic cables transmit the light from the circuit to the spout.

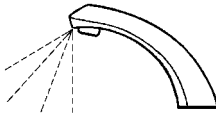

2. The faucet is activated by placing hands beneath the spray head, thus activating the Solenoid Valve. Tempered water flows for as long as hands continue to stay within the Sensor's range (30 second automatic shut off).



3. When hands are removed, the water flow automatically stops. The faucet is then ready for the next user.

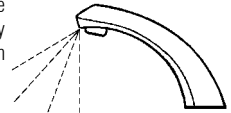

EBF-85 Faucet with Bak-Chek Tee for Hot and Cold Water Supply (shown with 4" trim plate)

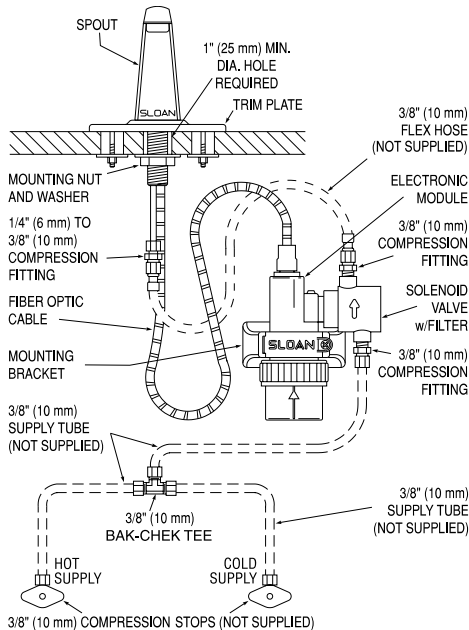

EBF-85 Faucet with ADM Variation Mixing Valve for Hot and Cold Water Supply (shown with 8" trim plate)

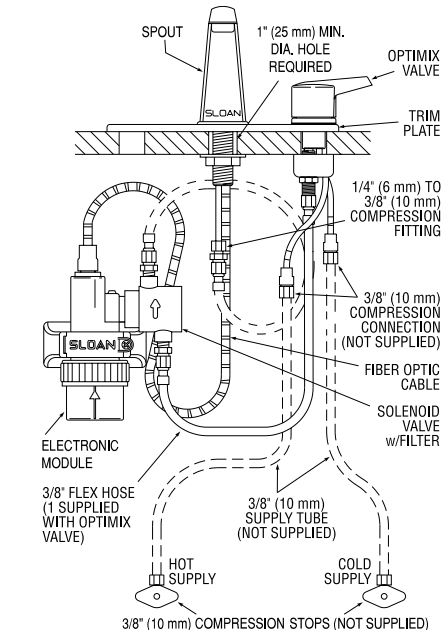

EBF-85 Faucet with BDM and BDT Variation Mixing Valves for Hot and Cold Water Supply (shown with 4" trim plate)

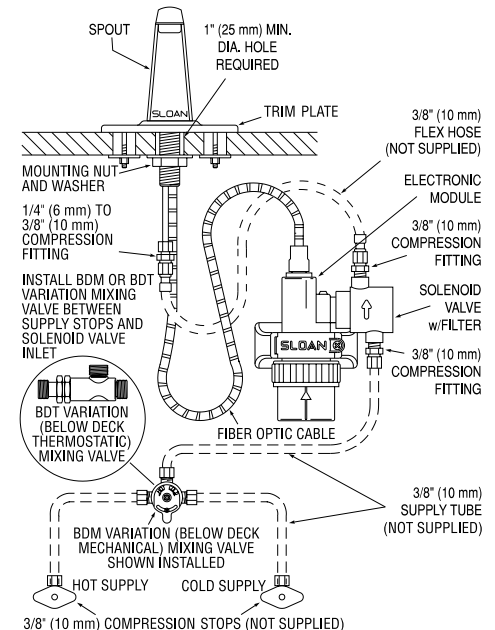

SLOAN VALVE COMPANY • 10500 SEYMOUR AVENUE • FRANKLIN PARK, IL 60131

Phone: 1-800-9-VALVE-9 or 1-847-671-4300 • Fax: 1-800-447-8329 or 1-847-671-4380 • <http://www.sloanvalve.com>